

DTC	B1144/B1145/35	Door Side Airbag Sensor (LH) Malfunction (2-Door only)
------------	-----------------------	---

CIRCUIT DESCRIPTION

The door side airbag sensor (LH) circuit consists of the airbag sensor assembly and door side airbag sensor (LH).

For details of the function of each component, see OPERATION on page RS-2 .

DTC B1144/B1145/35 is recorded when malfunction is detected in the door side airbag sensor (LH) circuit.

DTC No.	DTC Detecting Condition	Trouble Area
B1144/B1145/35	• Door side airbag sensor (LH) malfunction	<ul style="list-style-type: none"> • Door side airbag sensor (LH) • Airbag sensor assembly • Instrument panel wire harness • LH front door wire harness

WIRING DIAGRAM

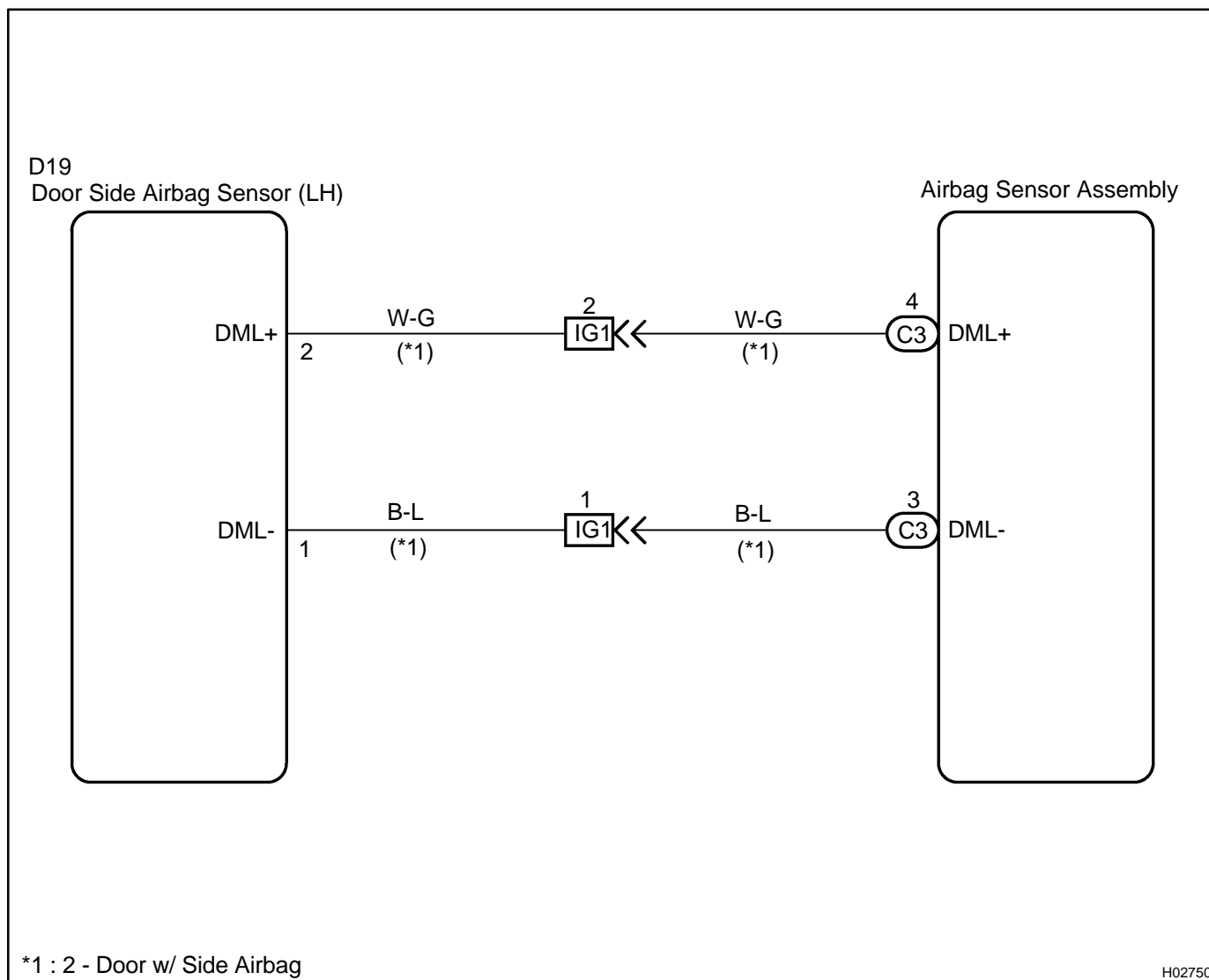

INSPECTION PROCEDURE

1 Prepare for inspection (See step 1 on page DI-390).

2 Check wire harness (to B+).

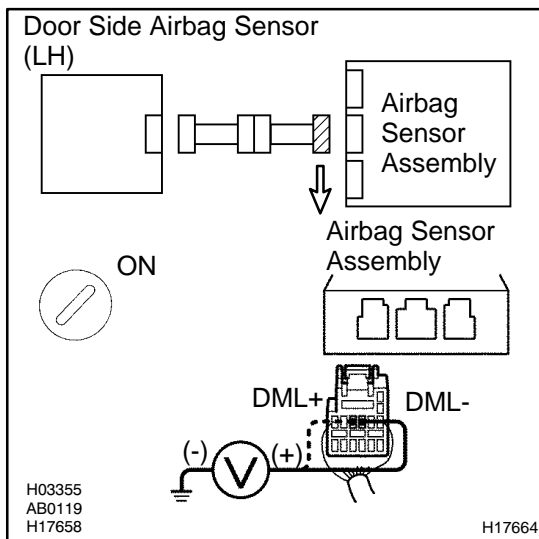
**CHECK:**

- Turn the ignition switch to ON.
- For the connector (on the airbag sensor assembly side) between the door side airbag sensor (LH) and the airbag sensor assembly, measure the voltage between body ground and each of DML+ and DML-.

OK:

Voltage: Below 1 V

NG

Go to step 8.

OK

3 Check wire harness (to ground).

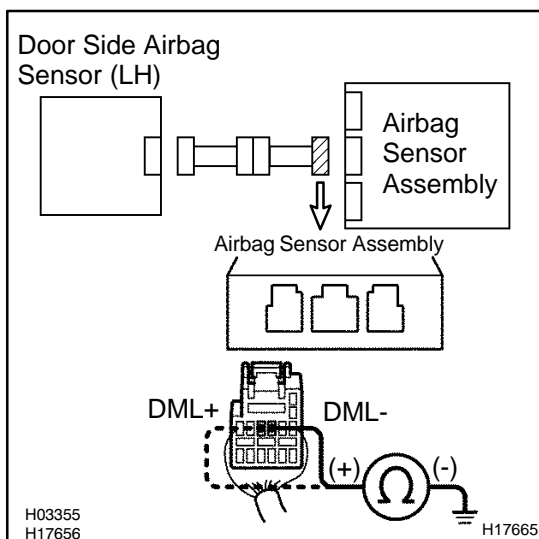
**CHECK:**

For the connector (on the airbag sensor assembly side) between the door side airbag sensor (LH) and the airbag sensor assembly, measure the resistance between body ground and each of DML+ and DML-.

OK:

Resistance: 1 MΩ or Higher

NG

Go to step 9.

OK

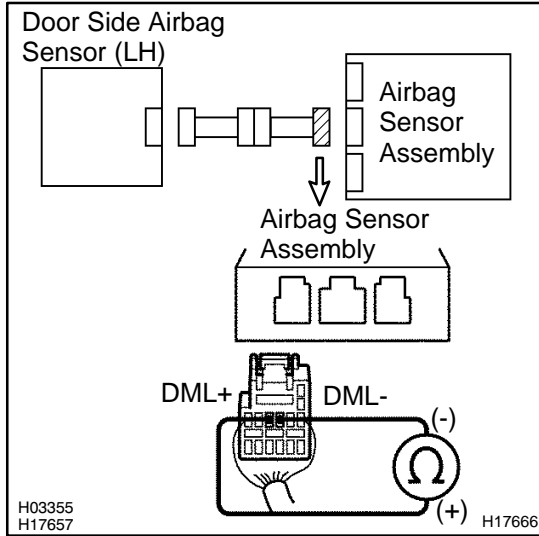
4 Check wire harness.**CHECK:**

For the connector (on the airbag sensor assembly side) between the door side airbag sensor (LH) and the airbag sensor assembly, measure the resistance between DML+ and DML-.

OK:

Resistance: 1 M Ω or Higher

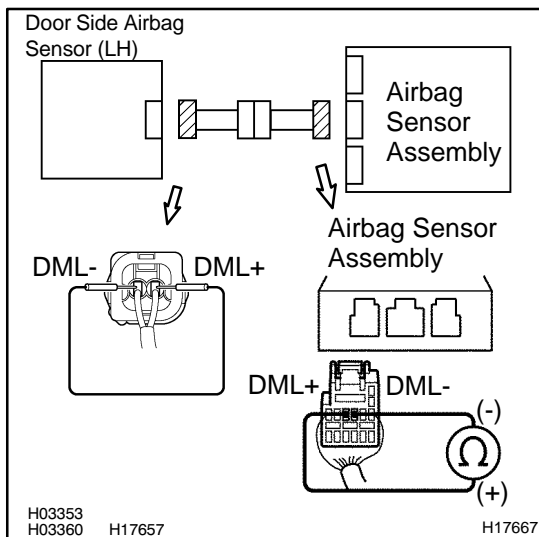
NG**Go to step 10.****OK****5 Check wire harness.****PREPARATION:**

Using a service wire, connect DML+ and DML- of the connector (on the door side airbag sensor (LH) side) between the airbag sensor assembly and the door side airbag sensor (LH).

CHECK:

For the connector (on the airbag sensor assembly side) between the door side airbag sensor (LH) and the airbag sensor assembly, measure the resistance between DML+ and DML-.

OK:

Resistance: Below 1 Ω

NG**Go to step 11.****OK**

6 Check door side airbag sensor (LH).

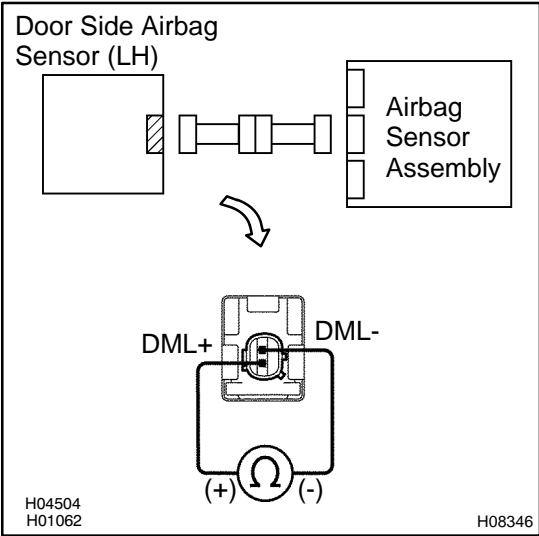

CHECK:
For the connector of the door side airbag sensor (LH), measure the resistance between DML+ and DML-.

OK:
Resistance: 300 - 1500 Ω

NG Replace door side airbag sensor (LH).

OK

7 Check airbag sensor assembly.

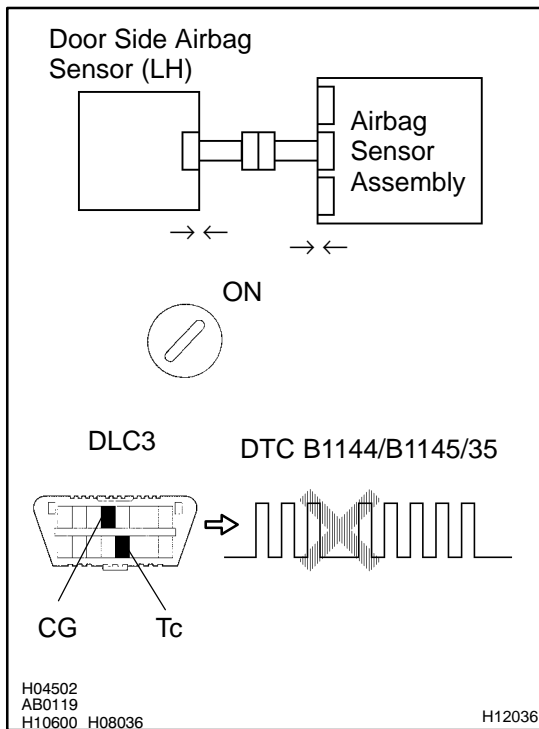

PREPARATION:

- Turn the ignition switch to LOCK.
- Disconnect negative (-) terminal cable from the battery, and wait at least for 90 seconds.
- Connect the door side airbag sensor (LH) connector and airbag sensor assembly connector.
- Connect negative (-) terminal cable to the battery, and wait at least for 2 seconds.

CHECK:

- Turn the ignition switch to ON, and wait at least for 20 seconds.
- Clear the DTC stored in memory (See page [DI-239](#)).
- Turn the ignition switch to LOCK, and wait at least for 20 seconds.
- Turn the ignition switch to ON, and wait at least for 20 seconds.
- Check the DTC (See page [DI-239](#)).

OK:

DTC 35 is not output.

HINT:

Codes other than code 35 may be output at this time, but they are not relevant to this check.

NG

Replace airbag sensor assembly.

OK

From the results of the above inspection, the malfunctioning part can now be considered normal. To make sure of this, use the simulation method to check.

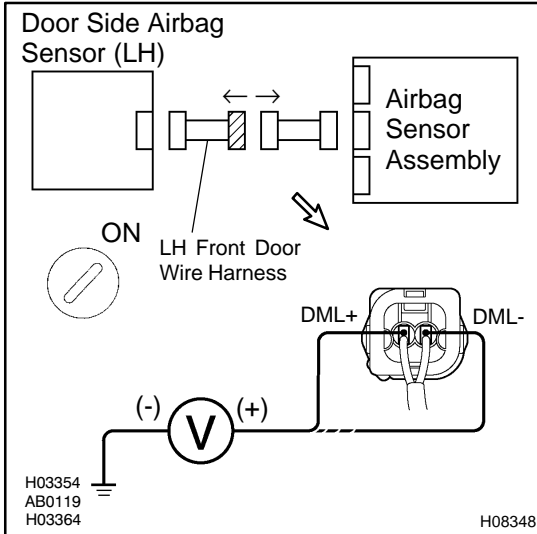
8 Check LH front door wire harness (to B+).**PREPARATION:**

Disconnect the LH front door wire harness connector on the airbag sensor assembly side.

CHECK:

- Turn the ignition switch to ON.
- For the connector (on the LH front door wire harness side) between the airbag sensor assembly and the LH front door wire harness, measure the voltage between body ground and each of DML+ and DML-.

OK:

Voltage: Below 1 V

NG

Repair or replace LH front door wire harness.

OK

Repair or replace harness or connector between airbag sensor assembly and LH front door wire harness.

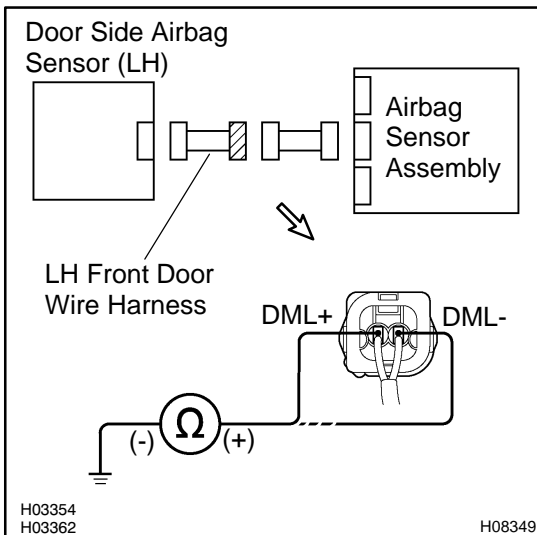
9 Check LH front door wire harness (to ground).**PREPARATION:**

Disconnect the LH front door wire harness connector on the airbag sensor assembly side.

CHECK:

For the connector (on the LH front door wire harness side) between the airbag sensor assembly and the LH front door wire harness, measure the resistance between body ground and each of DML+ and DML-.

OK:

Resistance: 1 MΩ or Higher

NG

Repair or replace LH front door wire harness.

OK

Repair or replace harness or connector between airbag sensor assembly and LH front door wire harness.

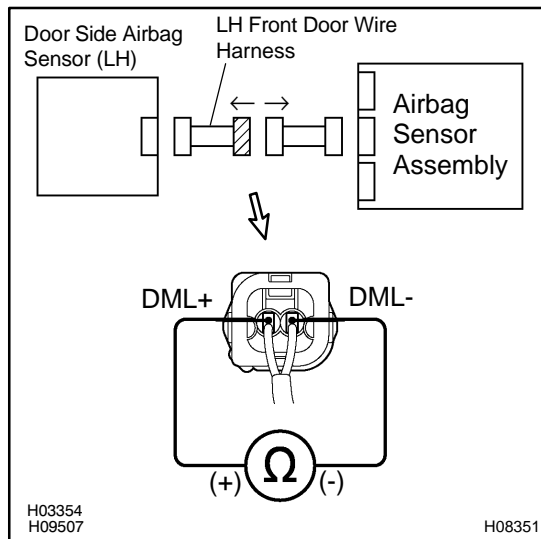
10 Check LH front door wire harness.**PREPARATION:**

Disconnect the LH front door wire harness connector on the airbag sensor assembly side.

CHECK:

For the connector (on the LH front door wire harness side) between the airbag sensor assembly and the LH front door wire harness, measure the resistance between DML+ and DML-.

OK:

Resistance: 1 M Ω or Higher

NG

Repair or replace LH front door wire harness.

OK

Repair or replace harness or connector between airbag sensor assembly and LH front door wire harness.

11 Check LH front door wire harness.

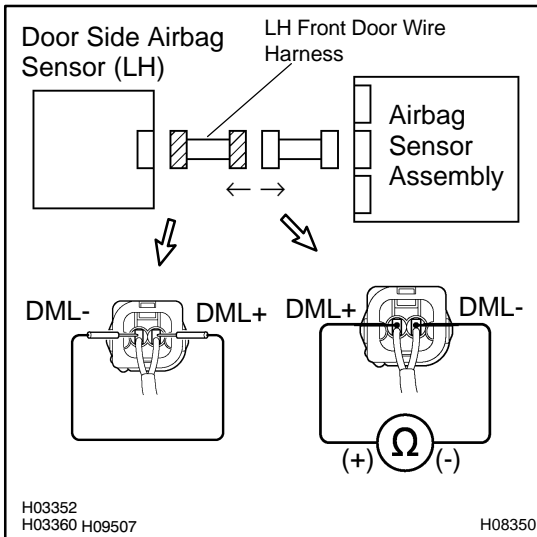

PREPARATION:

- Disconnect the LH front door wire harness connector on the airbag sensor assembly side.
- Using a service wire, connect DML+ and DML- of the connector (on the LH front door wire harness side) between the LH front door wire harness and the door side airbag sensor (LH).

CHECK:

For the connector (on the LH front door wire harness side) between the airbag sensor assembly and the LH front door wire harness, measure the resistance between DML+ and DML-.

OK:

Resistance: Below 1 Ω

NG

Repair or replace LH front door wire harness.

OK

Repair or replace harness or connector between airbag sensor assembly and LH front door wire harness.